

ZAZA2 PLS3

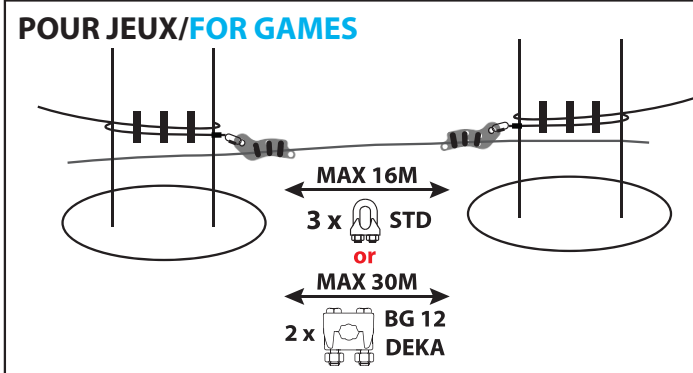

AVANTAGES/ADVANTAGE

- Facile à installer/ Easy to install
- TOUS TYPE DE PARCOURS/ALL TYPE COURSE

kN
CT/WLL 10kN

CÂBLE DE SÉCURITÉ
SAFETY CABLE
Ø 12
or 1/2"
ACIER/STEEL

ADAPTABLE
STD 12
or
ZAZA2 JAWS

NORMES
STANDARDS
EN 15567-1
EN 13411-1/7

ACIER INOXYDABLE
STAINLESS STEEL
INOX 316 L

X1
ZAZA2 PLS 3

=

X1
GO 10/LO 7/16
CT/WLL 1000KG

ADAPTABLE
3X STD 12
or
2X ZAZA2 JAWS

PLAQUE DE GUIDAGE INOX
GUIDING PLATE STAINLESS
OBLIGATOIRE! MANDATORY!

NO! Tyrolienne
NO! Zipline

EXEMPLES DE SYSTEMES DE FIXATIONS
FIXATION EXAMPLE

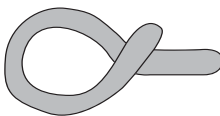
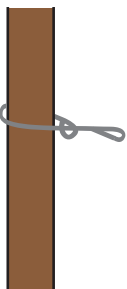

ELINGUE RONDE TEXTILE TYPE "E"
ROUND TEXTILE SLING TYPE "E"

NORMES: EN 13411-1/7
STANDARDS:

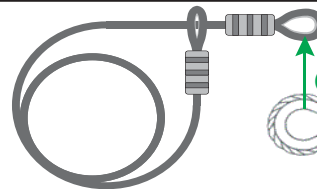
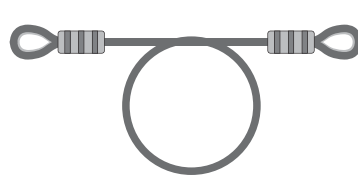

CÂBLES Ø12 or 1/2"
ÂME METALLIQUE
OK! METALLIC CORE

Chain Ø 8/10
Grade 80 mini

STD 12 = 25 Nm

JAWS = 45 Nm

OUTIL à SERTIR
CRIMPER
x130 kN

EN15567-1
EN13411-3
STANDARDS
ACCT

Operation 1

OK



X1 GO10-LO7/16"

NORMES DE MONTAGE STANDARDS OF ASSEMBLY



EN 15567-1
EN 13411-1/7
STANDARDS - ACCT

Operation 2

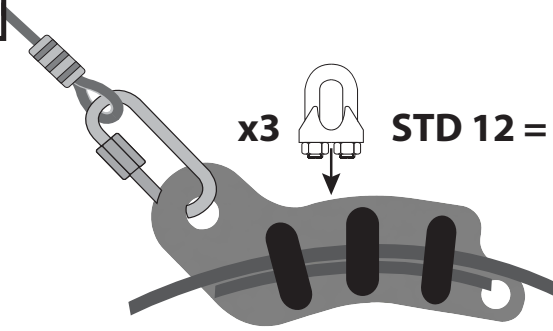

x3

STD 12 = EN 13411-5



PLAQUE DE GUIDAGE OBLIGATOIRE!
MANDATORY GUIDING PLATE !

Operation 2 BIS

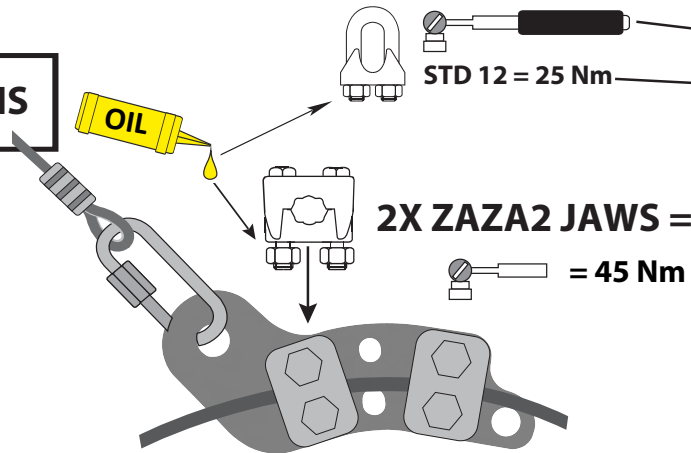

STD 12 = 25 Nm

2X ZAZA2 JAWS =

= 45 Nm

Même sens de montage
Same assembly direction

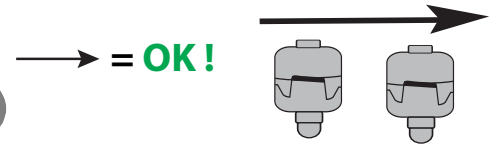

PLAQUE DE GUIDAGE OBLIGATOIRE!
MANDATORY GUIDING PLATE !

Operation 3

PLATINE DE DEPART
STARTING PLATE

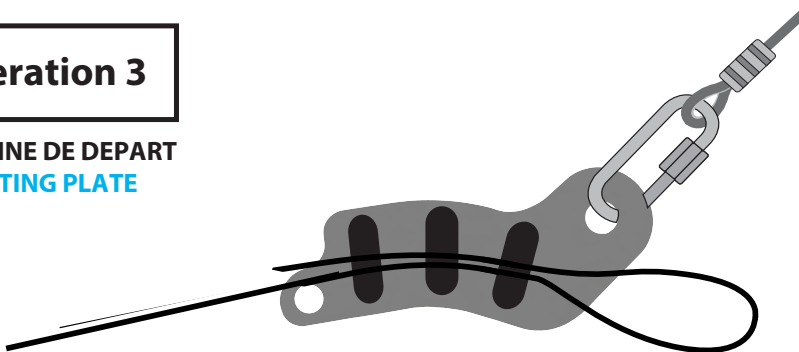

NORMES DE MONTAGE STANDARDS OF ASSEMBLY



EN 15567-1:2015
EN 13411-1/7
STANDARDS - ACCT

OBSERVE FITTING ORIENTATION OF JAWS CLAMPS

OBSERVER LE SENS DE MONTAGE DES JAWS

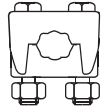

ZAZA2 JAWS

= OBSERVE THE DIRECTION OF CIRCULATION OF THE SAFETY HOOK

= OBSERVER LE SENS DE CIRCULATION DU CROCHET

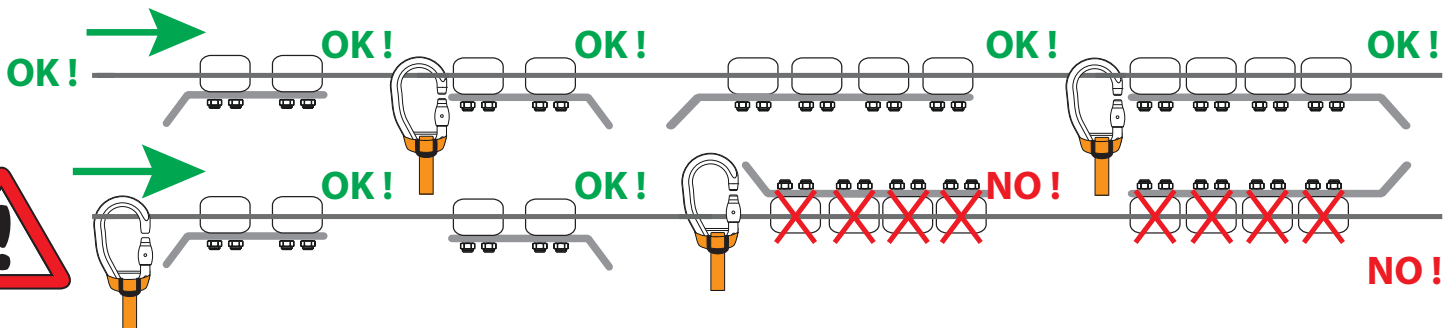
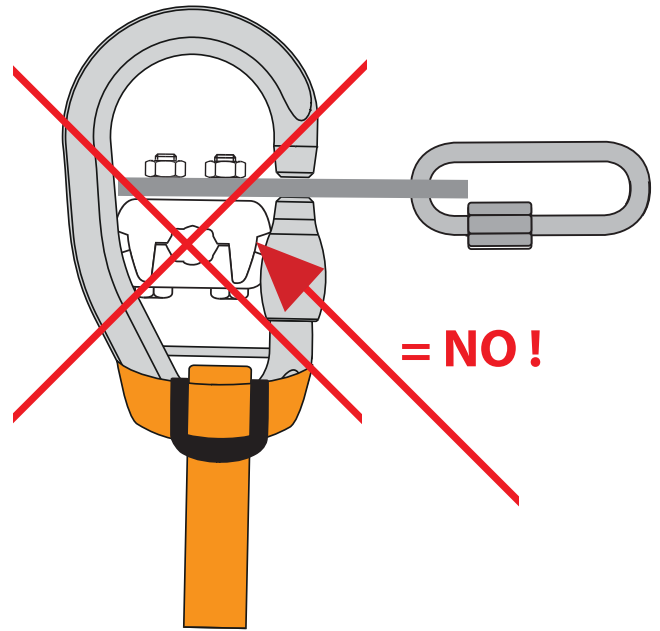
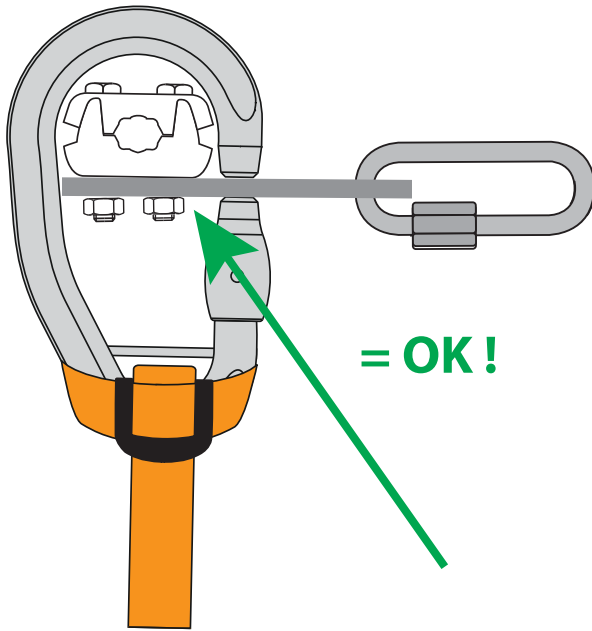
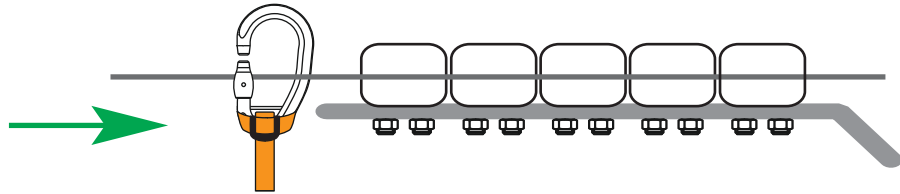

Operation 4

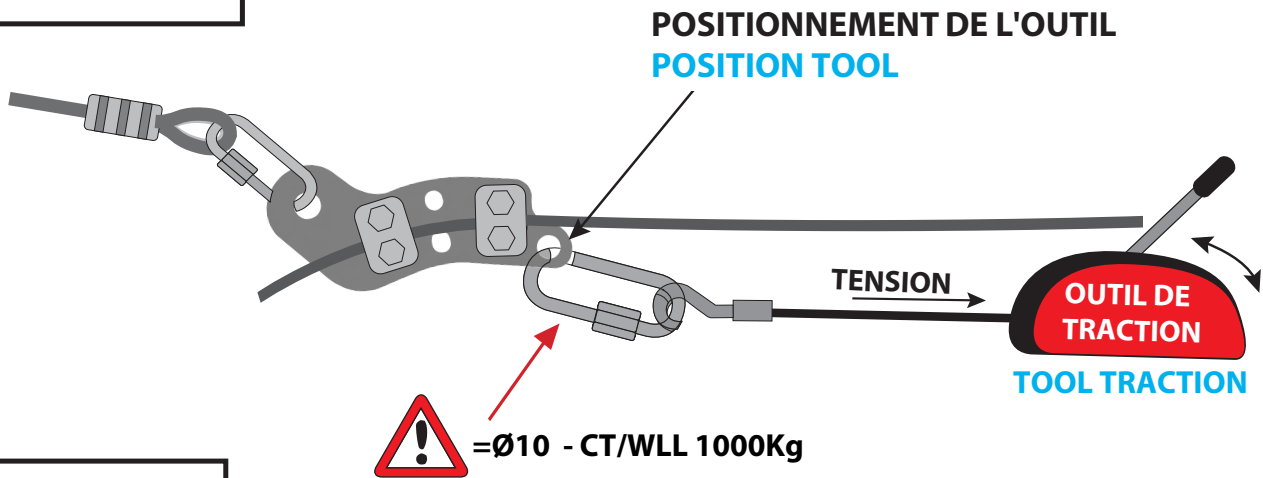

Operation 5

● RECOMMANDATION DE MONTAGE / RECOMMENDATION ASSEMBLY

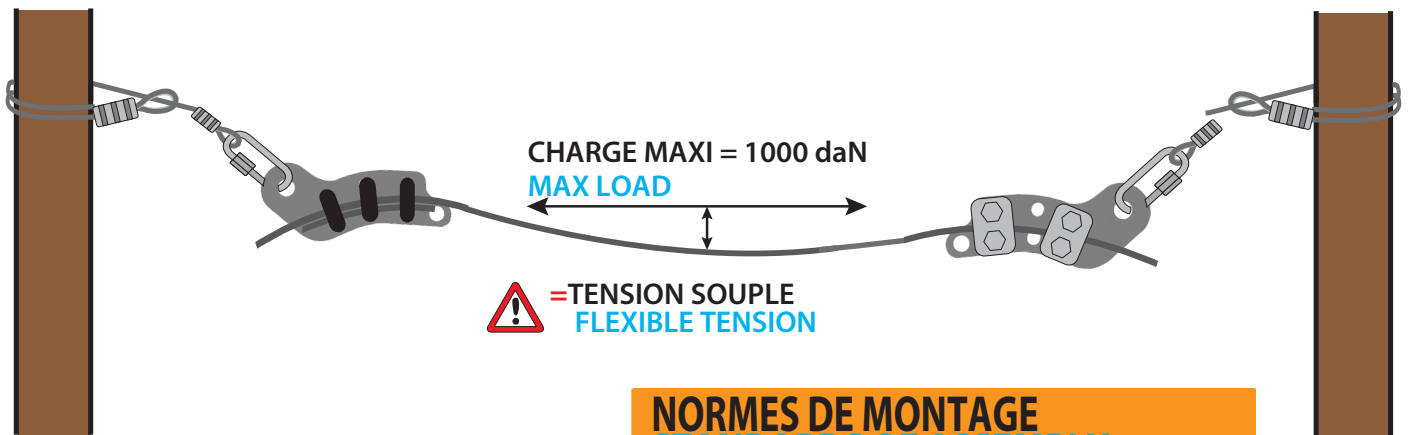

NORMES DE MONTAGE
STANDARDS OF ASSEMBLY



EN 15567-1
EN 13411-1/7
STANDARDS - ACCT

Operation 6

● JONCTION
JUNCTION

Exemples (non contractuel)
de systèmes de fixations
NOT Contractual examples
system of fixing

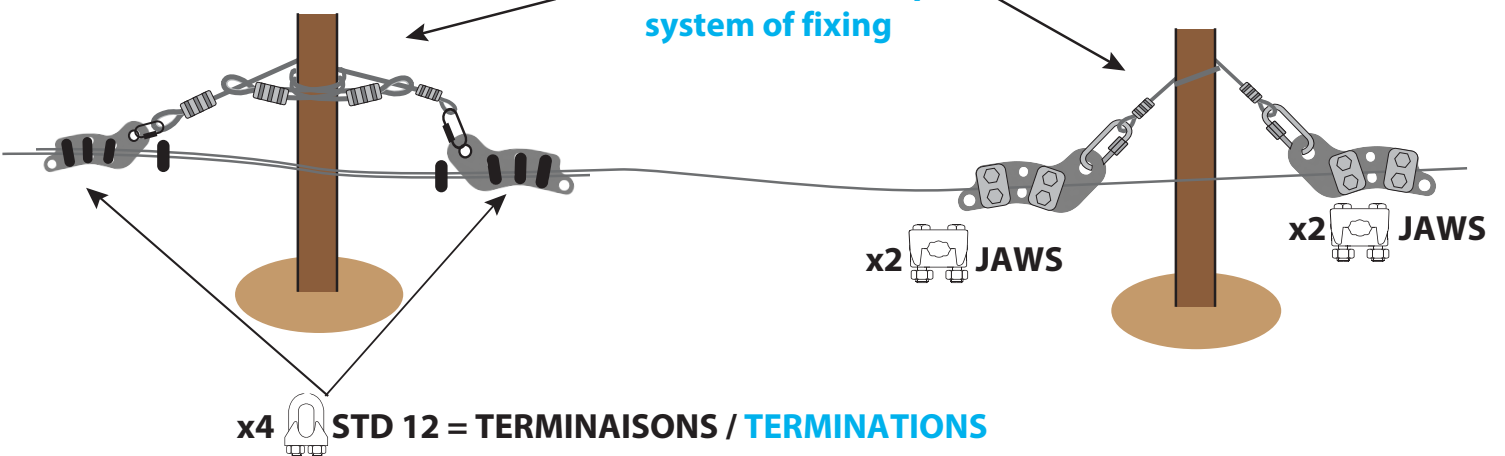

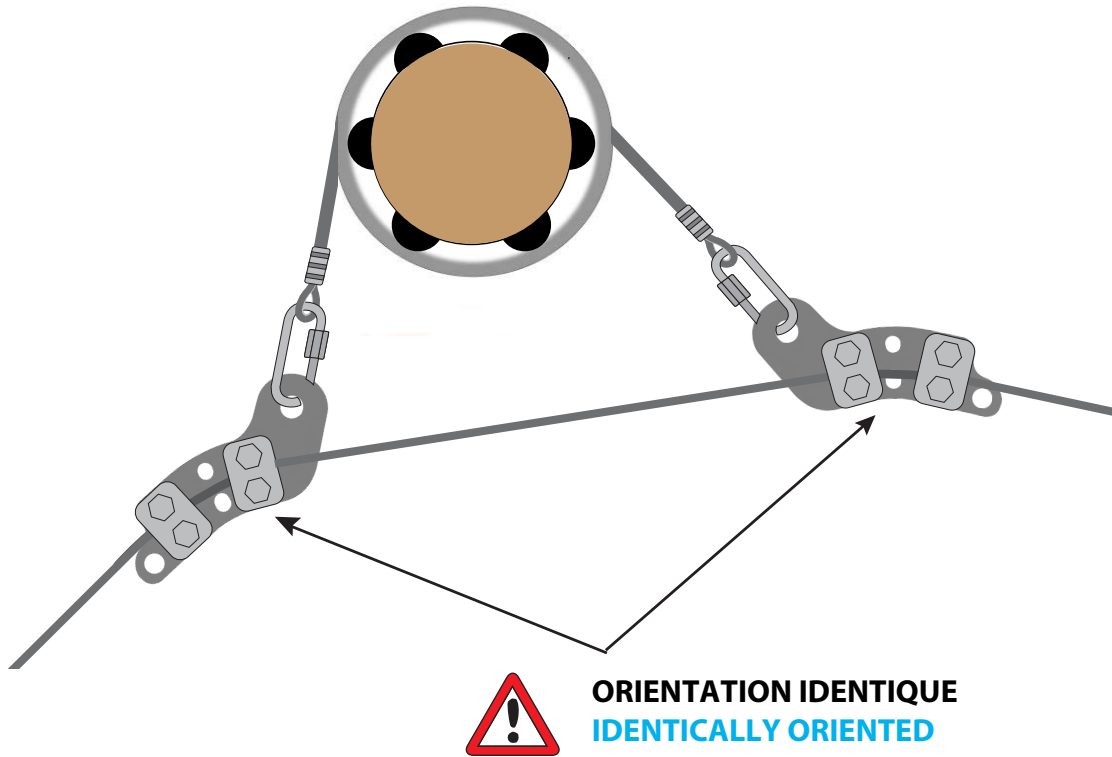

Operation 7

• Montage pour jeux roulants Assembly for rolling games

